

ЕЛЬПАСО / ЭЛЬПАСО Вітрина / Витрина REG1W3D/20/9

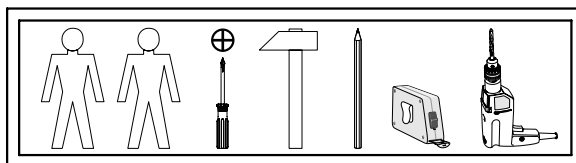

A	B	C		D
1	S314 123	1942	395	1/6
2	S314 124	1942	395	1/6
3	S314 920	1969	393	1/6
4	S314 921	1969	500	1/6
5	LH 561	561	14	1/6
6	S314 125	1294	395	2/6
7	S314 214	900	395	2/6
8	S314 222	900	395	2/6
9	S314 302	479	390	2/6
10	S314 307	867	390	2/6
11	S314 308	372	390	2/6
12	S314 309	867	395	2/6
13	S314 407	867	70	2/6
14	S314 575	867	80	2/6
15	S314 318	476	380	3/6
16	S314 013	496	608	4/6
17	S314 030	396	608	4/6
18	S314 031	396	1360	5/6
19	S314 032	496	1360	6/6

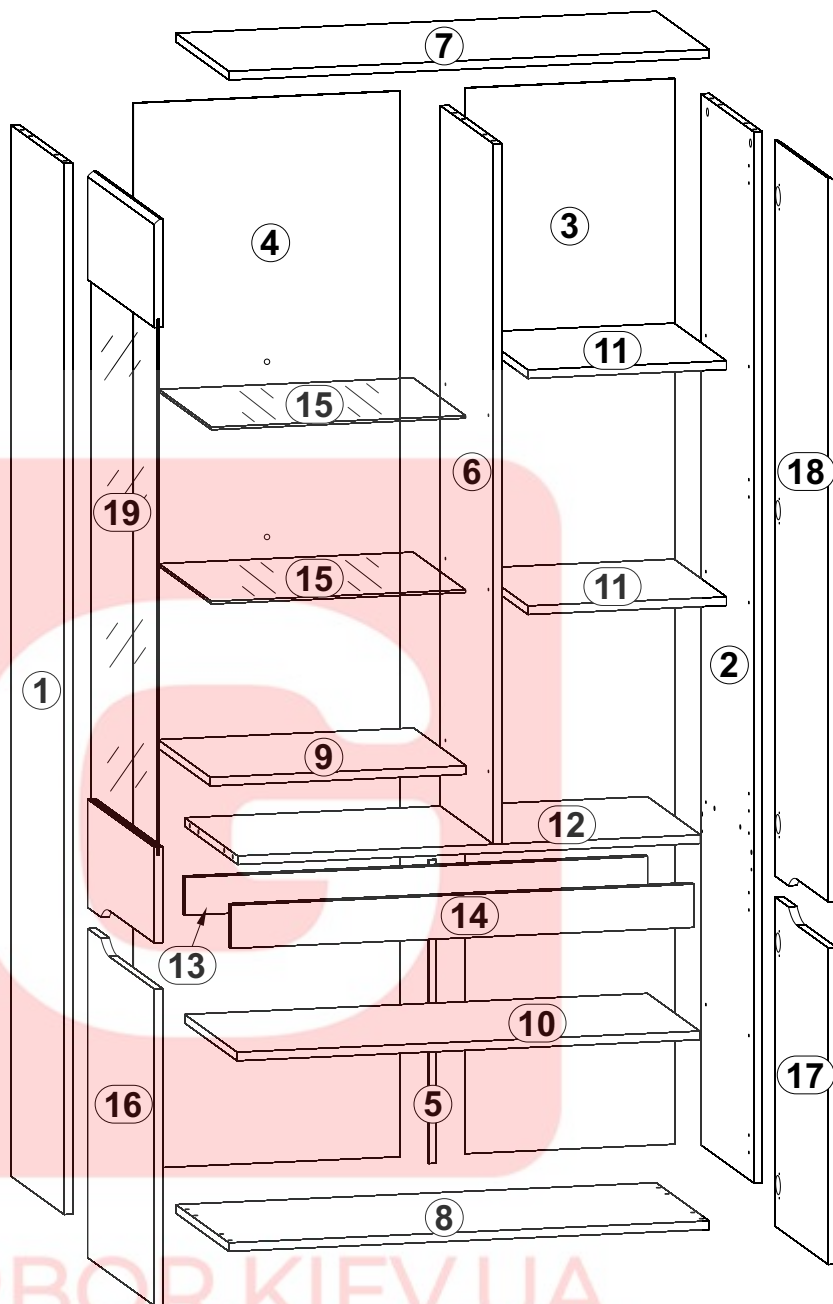
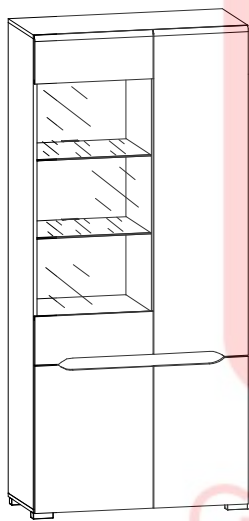

9x a44	9x b19 D5	16x d1 $\phi 5 \times 17$ mm	8x d3 $\phi 5 \times 17$ mm	6x e1 $\phi 7 \times 50$ mm	20x f1 $\phi 8 \times 30$ mm	4x k77 84x40/25 mm	80x l1
1x n26/1	8x p36 $\phi 4 \times 25$ mm	1x p38 $\phi 3,5 \times 16$ mm	18x p51 $\phi 3,5 \times 15$ mm	2x o43/1	1x o43/6	14x r1 $\phi 15 \times 12$ mm #16	
14x r42 20/11	6x s2 $\phi 16$	1x z1					

1

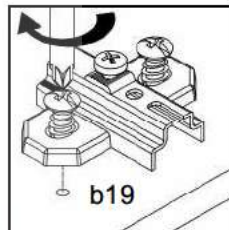
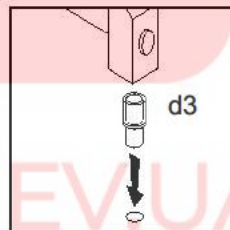
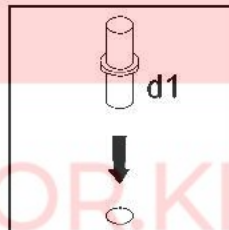
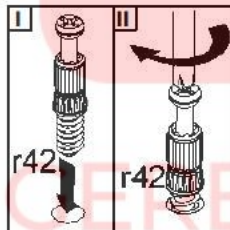
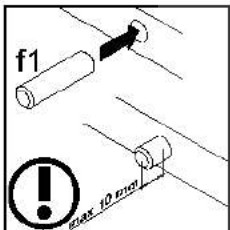
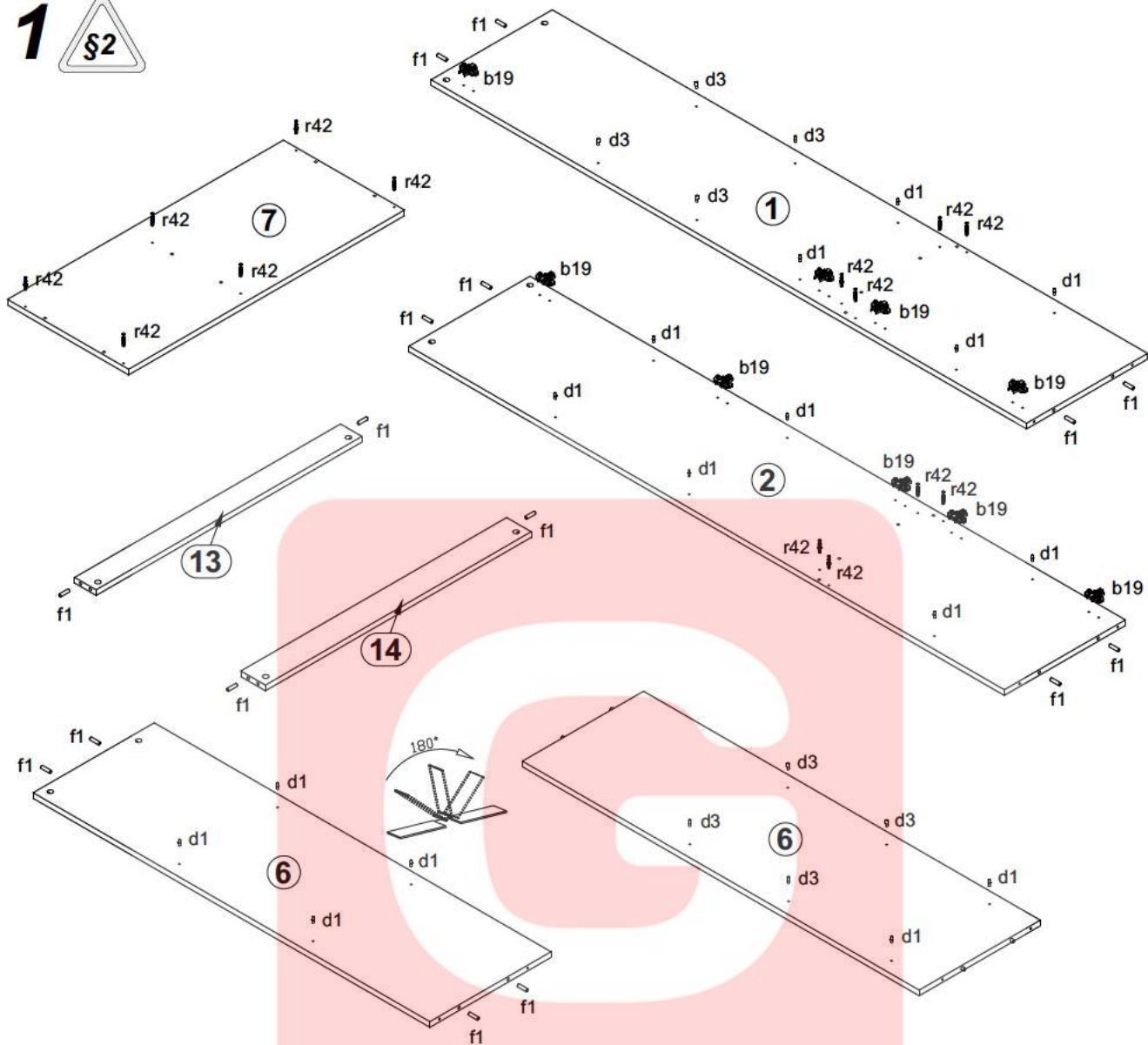

2

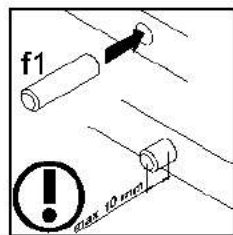
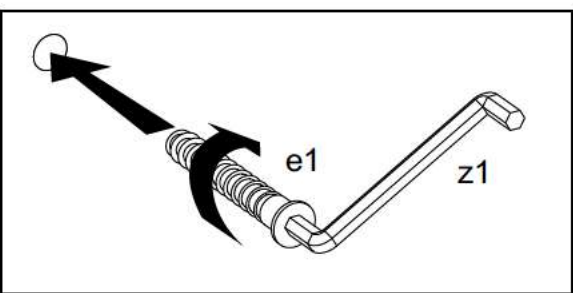
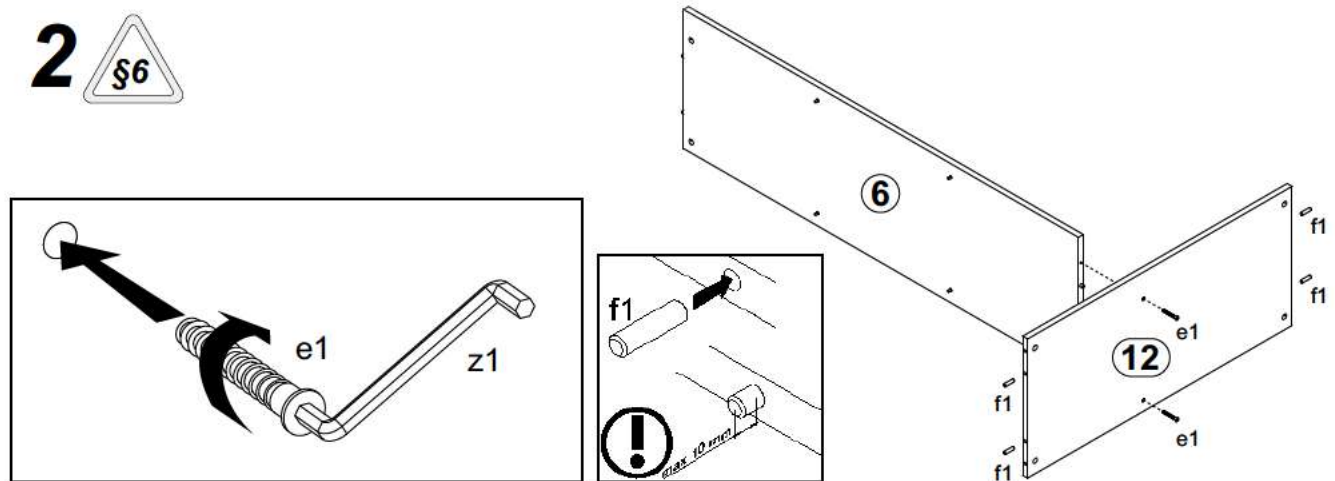

3

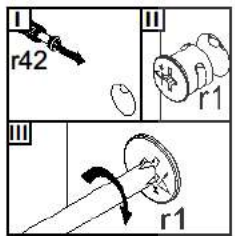
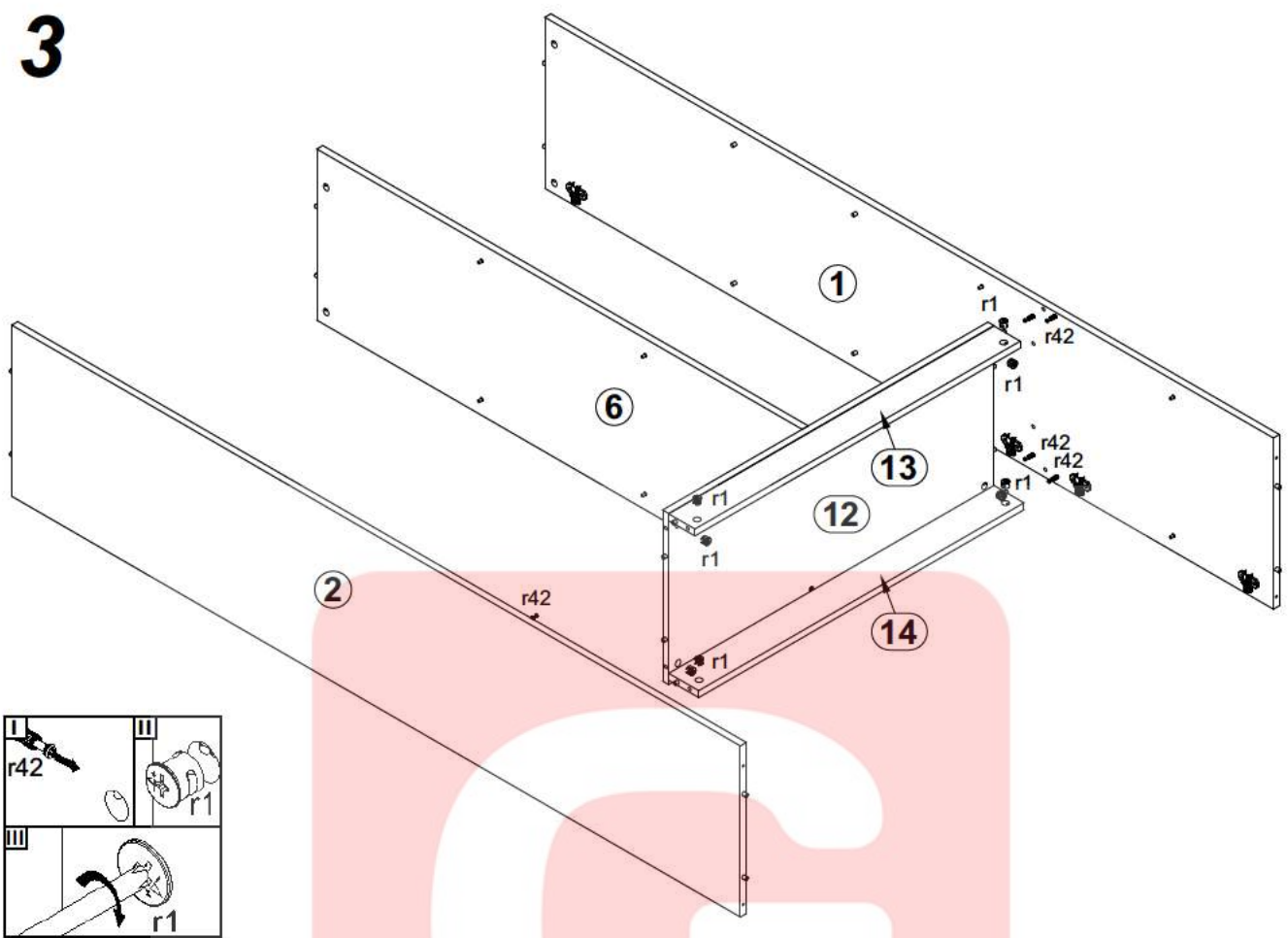

4

