

A	B	C	D	
1	S383 00005	446	264	3/3
2	S383 00006	804	446	3/3
3	S383 11005	815	385	1/3
4	S383 11006	815	385	1/3
5	S383 11009	815	385	1/3
6	S383 11010	815	385	1/3
7	S383 22005	1350	403	2/3
8	S383 22006	1350	403	2/3
9	S383 33003	425	380	2/3
10	S383 99003	387	348	2/3
11	S383 9004	840	448	1/3
12	ZP 5513	377	140	2/3
13	BP 511	350	140	1/3
14	BP 512	350	140	1/3

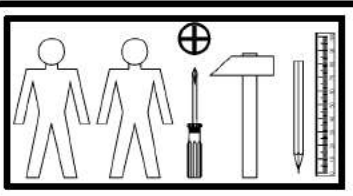

4x a44	4x b19	5x 128mm c409	8x Ø6x17 mm d1	8x Ø7x50 mm e1	12x Ø5x9 mm e19	30x Ø6x13 mm e3	16x Ø8x30 mm f1	12x Ø6,5x40 mm f25
6x Ø6x30 mm f9	6x k82\1	6x k82\2	45x l1	10x 20x13x3,5 l n108	10x silikon o21	8x Ø3,5x15 mm p51	10x Ø2,9x16 mm p55	10x Ø4x13 mm p93
20x Ø15x12 mm #16 r1	20x 20/11 r42	3x 350 mm w45\CL	3x 350 mm w45\CR	3x 350 mm w45\DL	3x 350 mm w45\DR	6x Ø16 s2	1x 4 mm z1	
							1x n26\1	1x Ø3,5x16 mm p38

**1** 

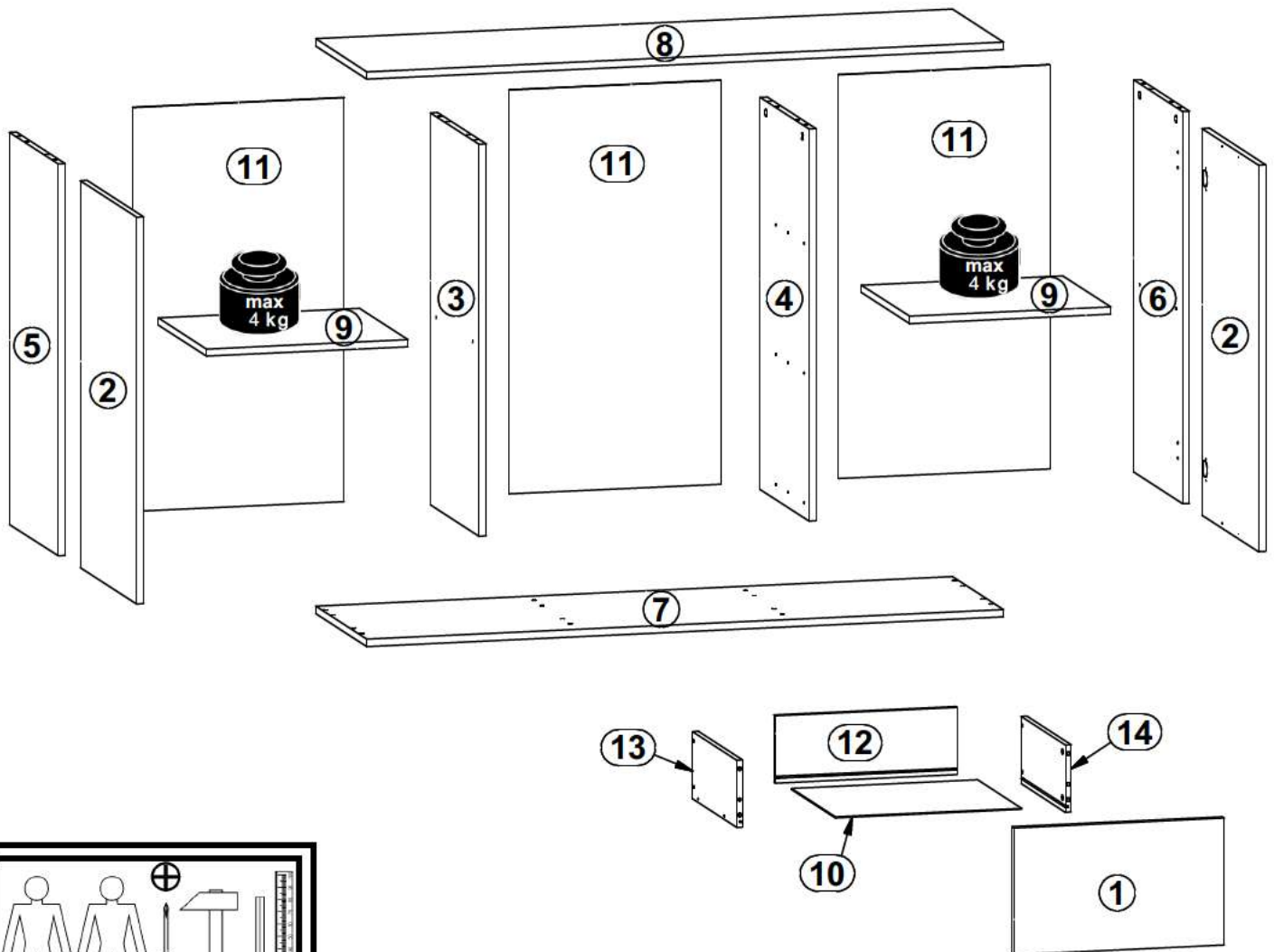
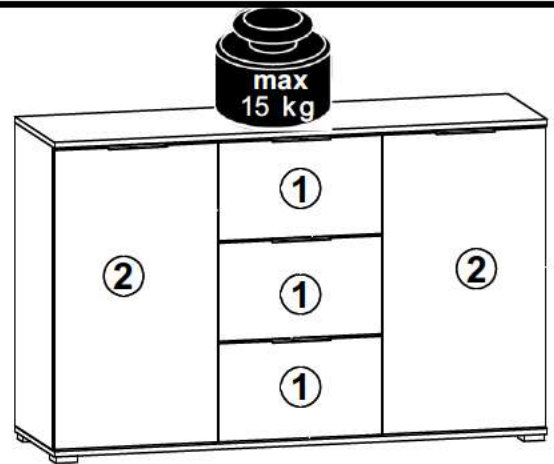
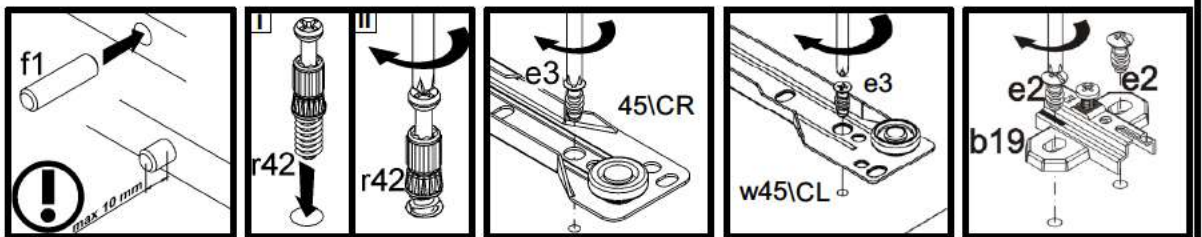
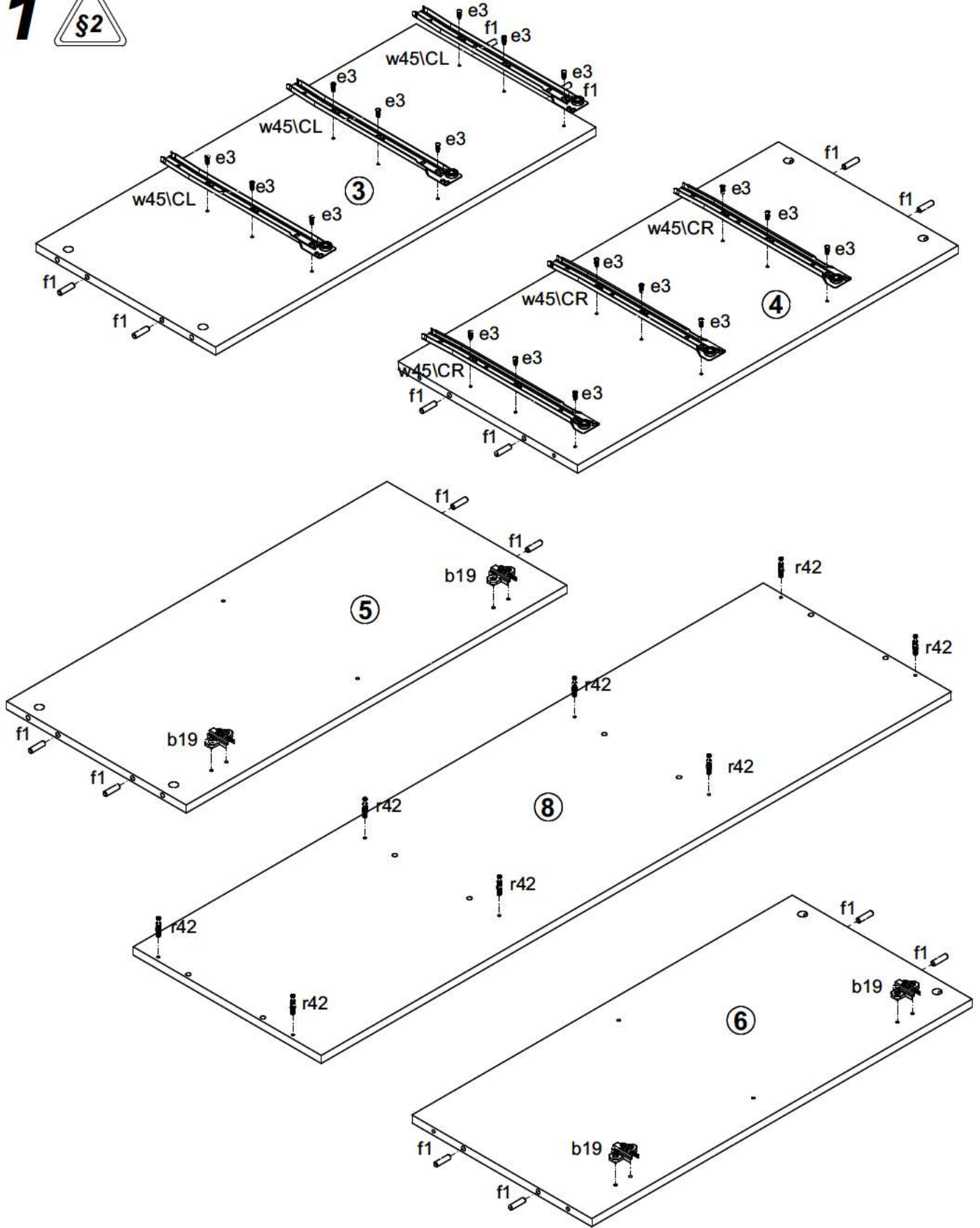

# 2

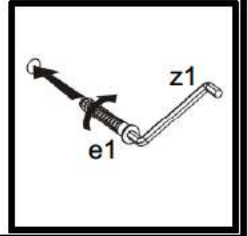
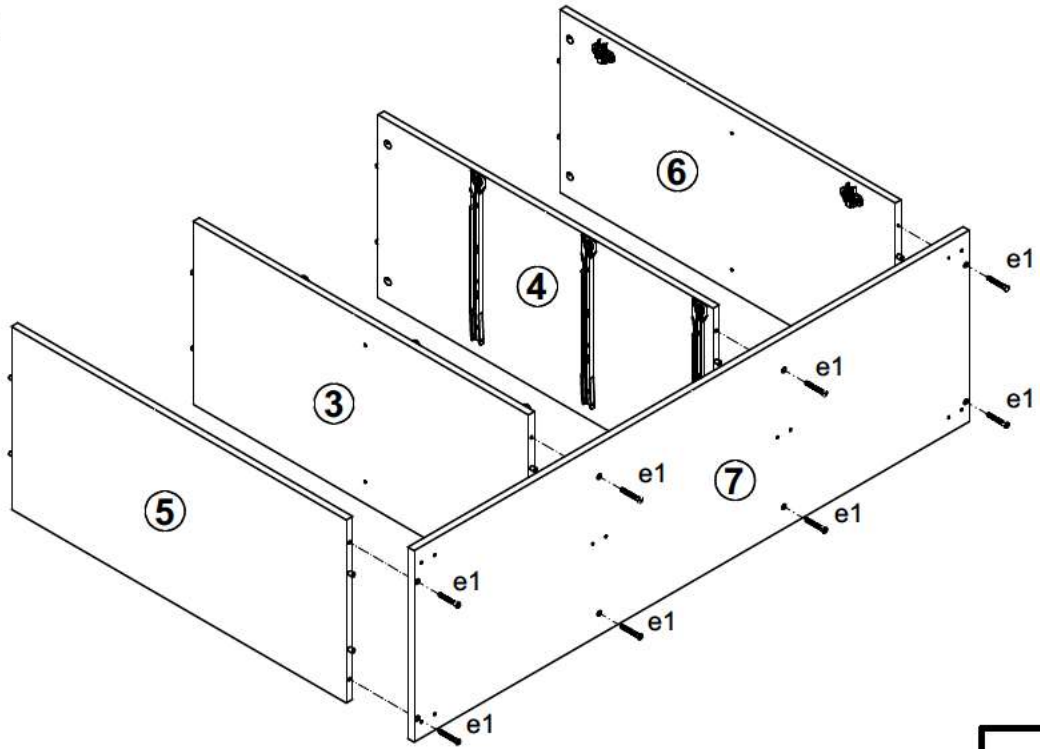

# 3

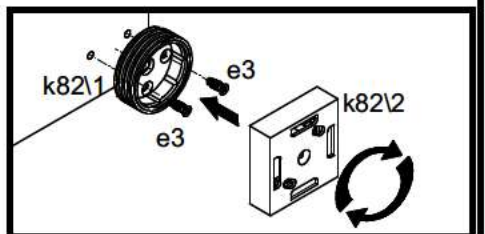
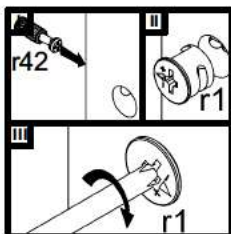
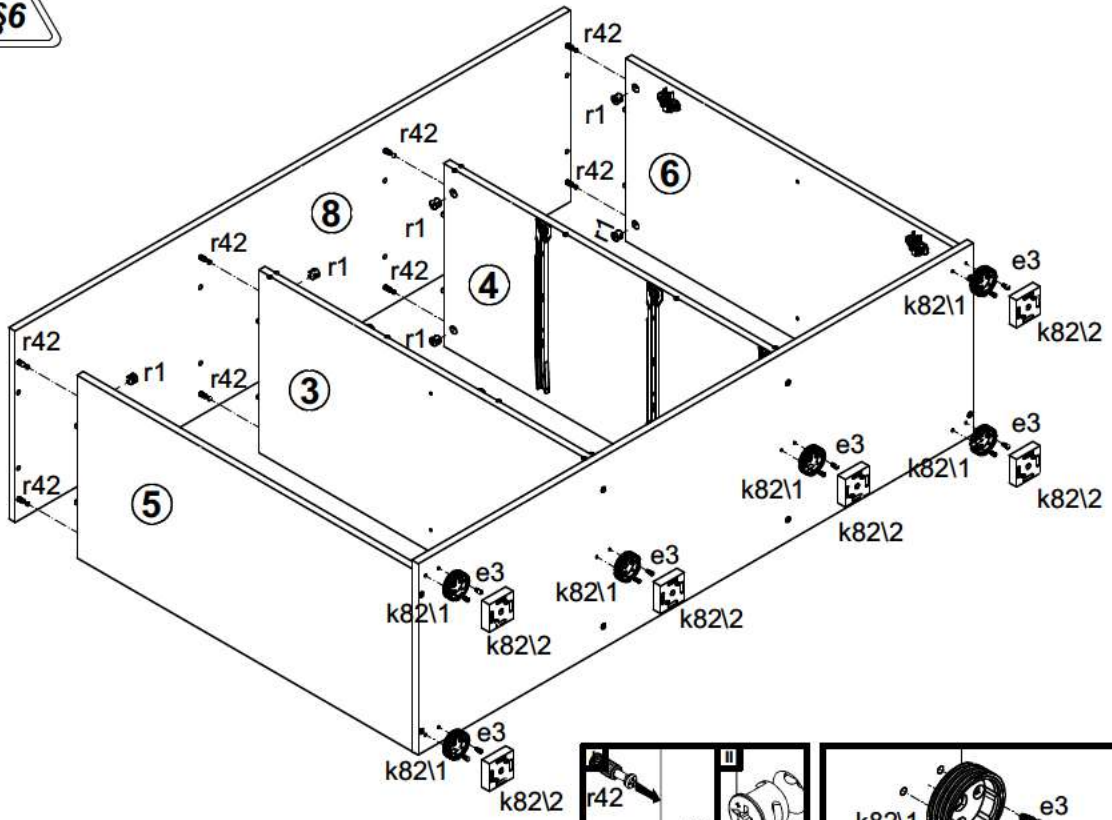



# 4

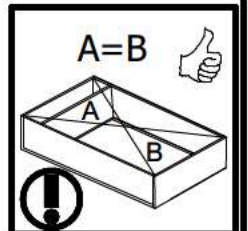
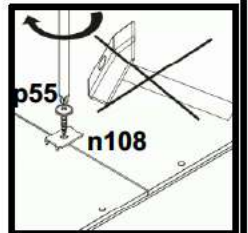
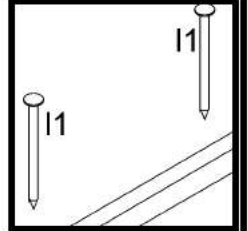
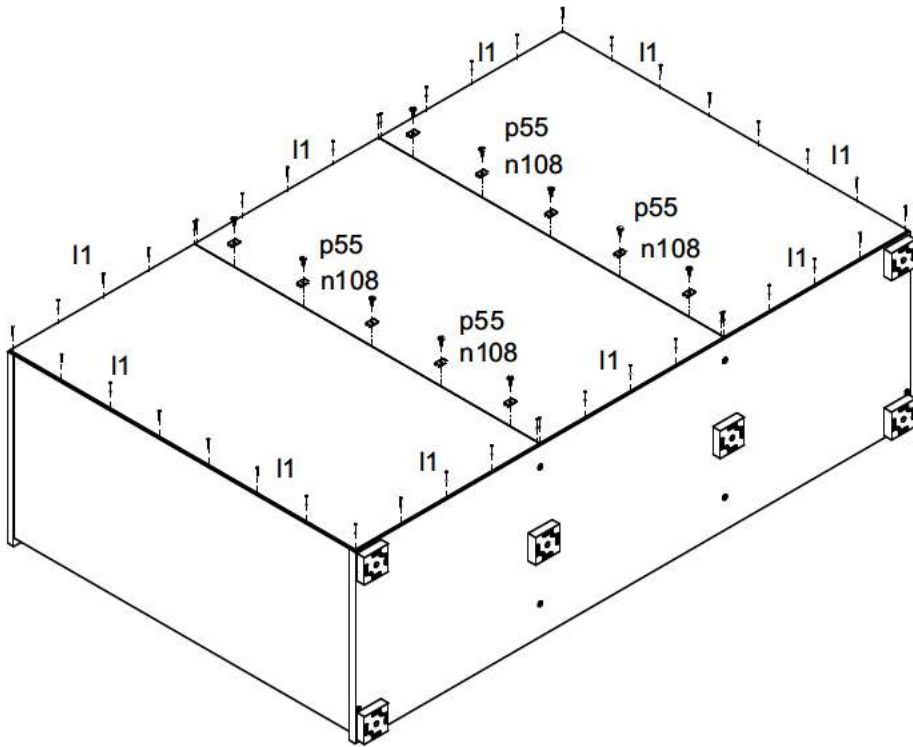

# 5

