

A	B	C		D
1	BK1-014	490	893	3/3
2	BK1-015	490	893	3/3
3	BK1-016	490	200	3/3
4	BK1-124	2000	565	1/3
5	BK1-125	2000	565	1/3
6	BK1-126	1984	525	1/3
7	BK1-216	120	565	2/3
8	BK1-217	120	565	2/3
9	BK1-218	1527	565	2/3

10	BK1-314	1482	525	2/3
11	BK1-315	485	525	2/3
12	BK1-316	485	525	2/3
13	BK1-317	981	525	2/3
14	BK1-918	320	48	3/3
15	BK1-915	2005	498	1/3
16	BK1-916	2005	498	1/3
17	BK1-917	2005	498	1/3
18	LH-1983	1983	14	1/3
19	DR-976	976		2/3
20	BK1-408	100	100	2/3

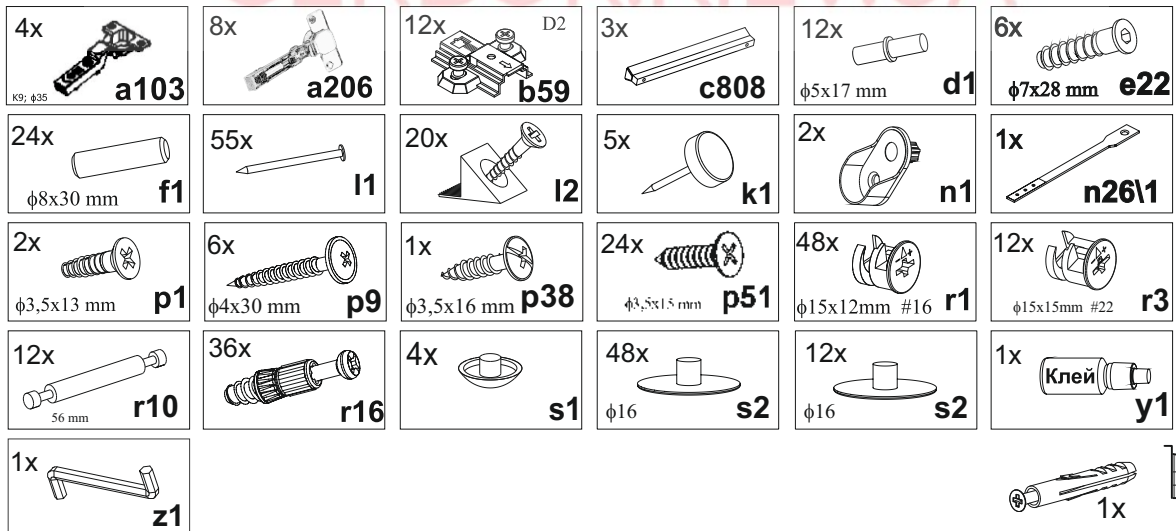

2

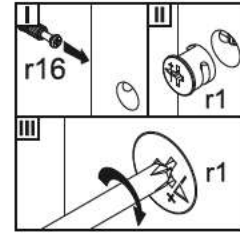
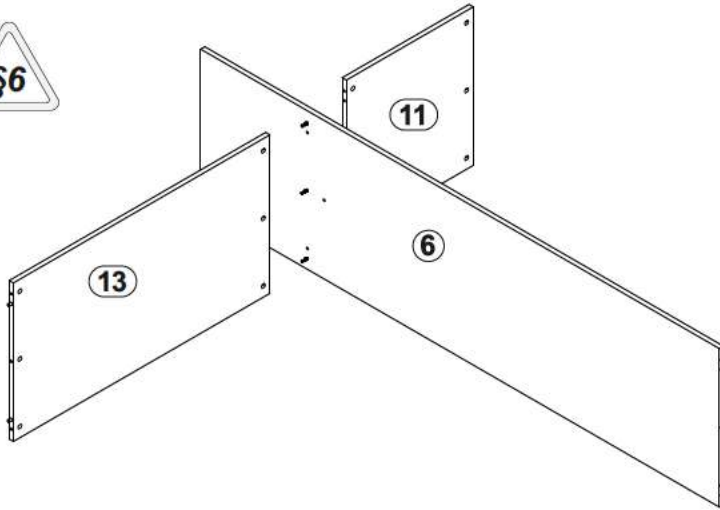

3

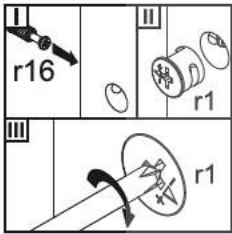
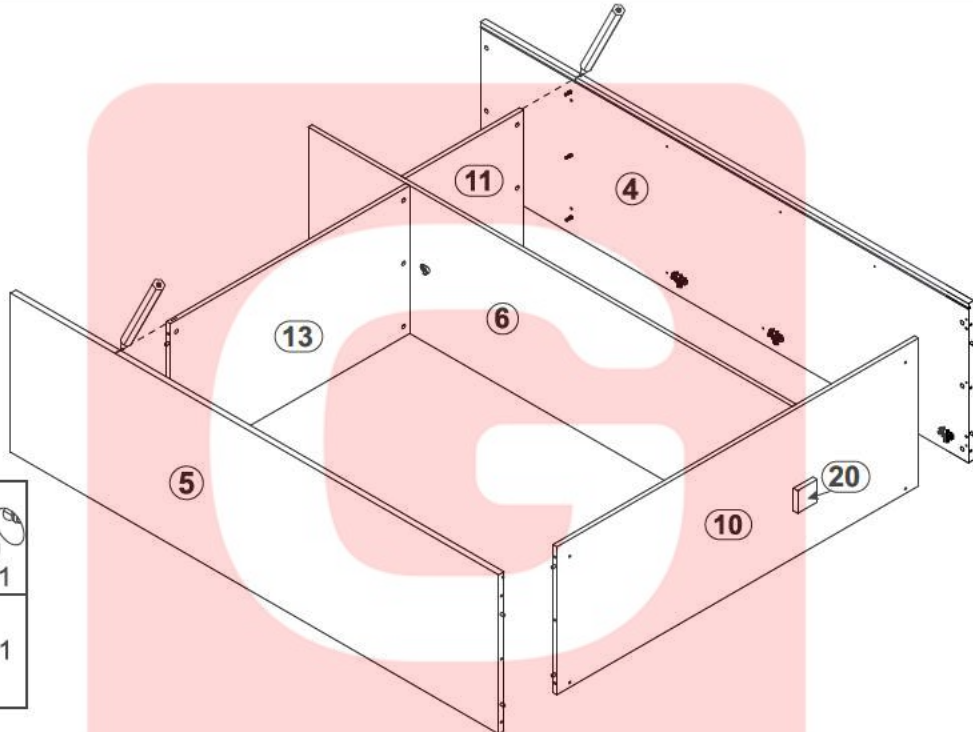

4

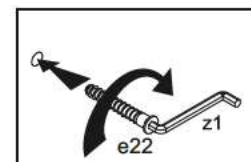
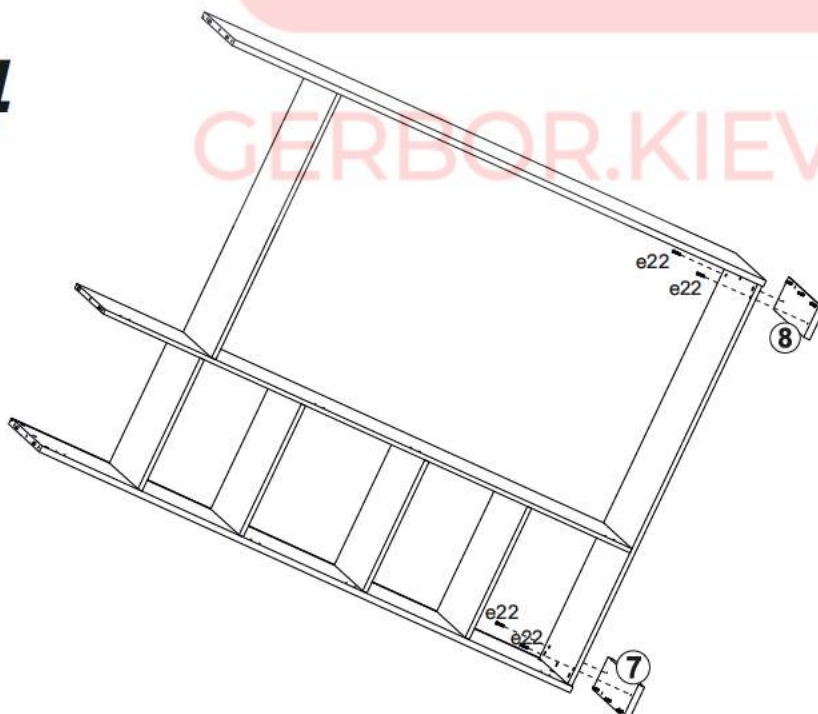

5

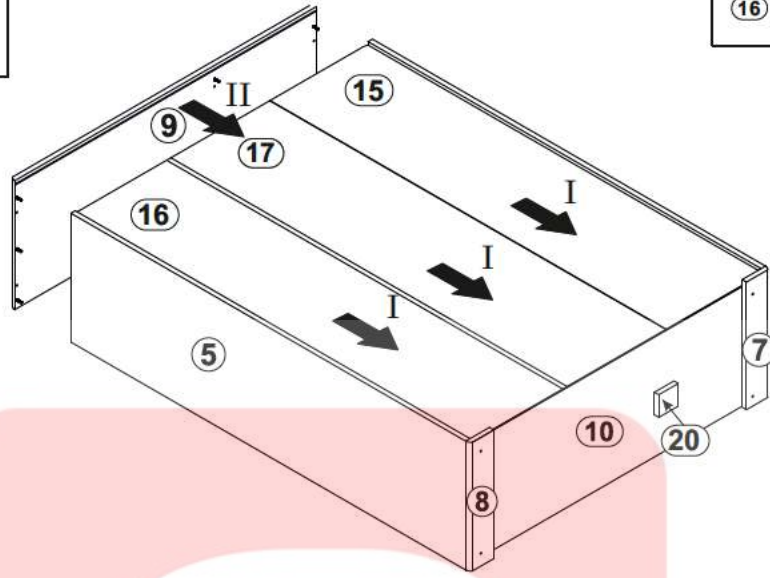
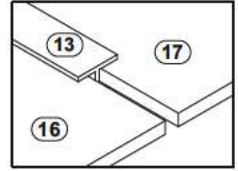
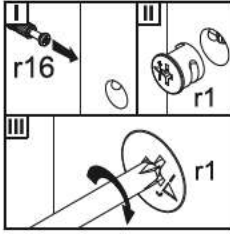

6

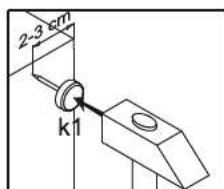
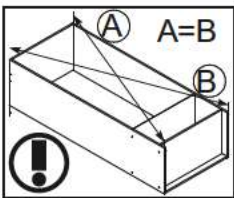
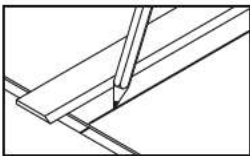
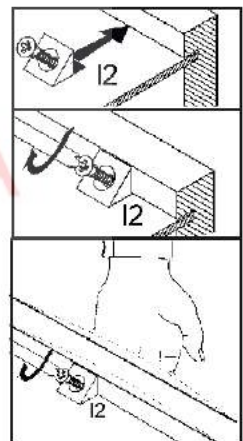
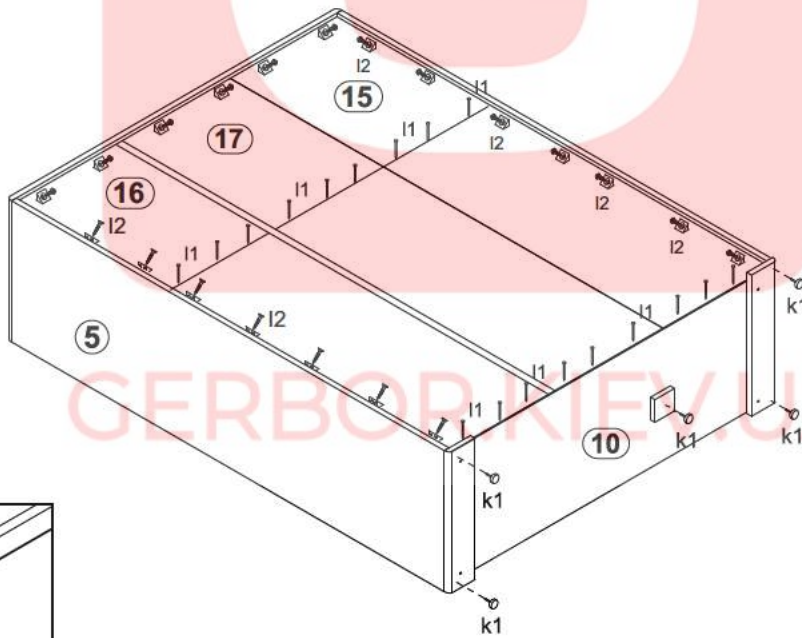

7

