

A	B	C	D
1	S314 118	1942	540 1/3
2	S314 119	1942	540 1/3
3	S314 911	1969	446 1/3
4	LH 1941	1941	14 1/3
5	S314 211	900	540 2/3
6	S314 212	900	540 2/3
7	S314 305	867	540 2/3
8	S314 406	867	160 2/3
9	S314 575	867	80 2/3
10	DR 862	862	2/3
11	S314 023	446	468 3/3
12	S314 024	446	468 3/3
13	S314 025	446	1500 3/3
14	S314 026	446	1500 3/3

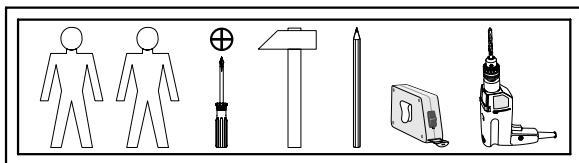

10x a44	10x b19	6x φ7x50 mm e1	18x φ8x30 mm f1	4x 84x40/25 mm k77	70x l1	2x n1	1x n26\1
2x φ3,5x13 mm p1	8x φ4x25 mm p36	7x φ3,5x16 mm p38	20x φ3,5x15 mm p51	18x φ15x12 mm #16 r1	18x 20/11 r42	6x φ16 s2	1x z1

1

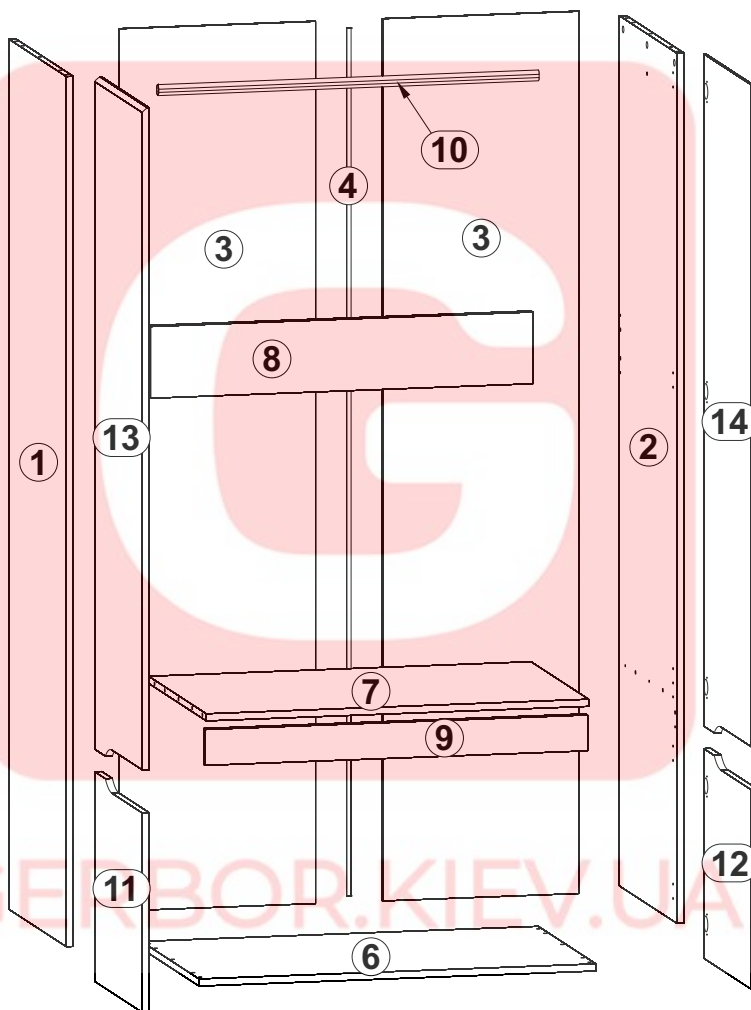
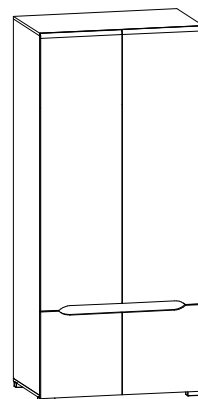
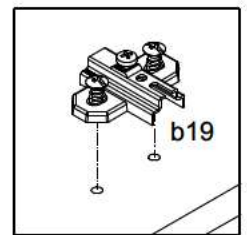
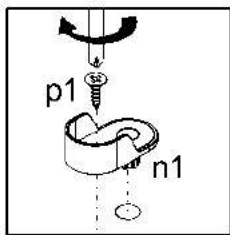
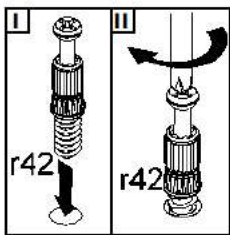
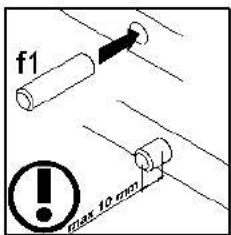
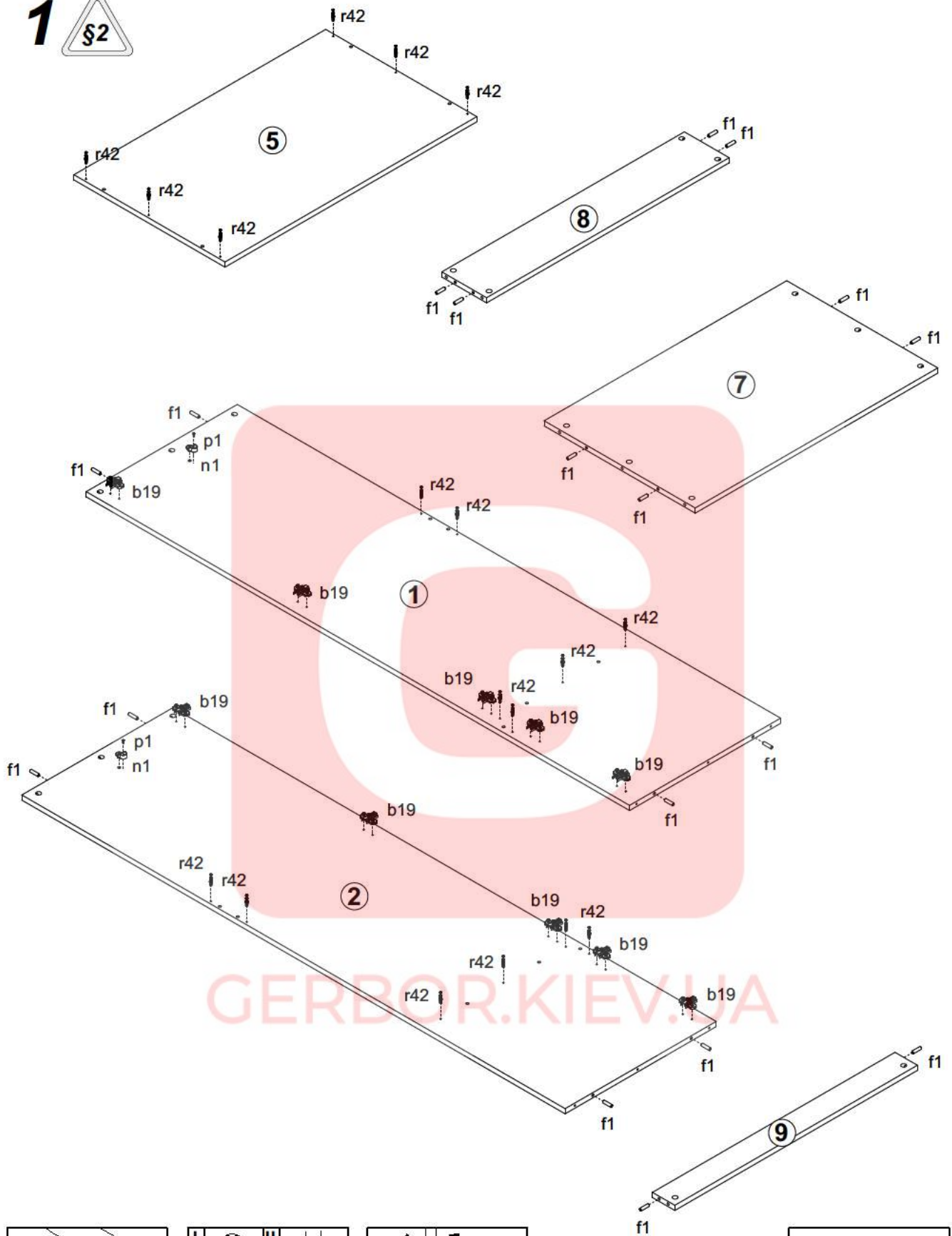

2

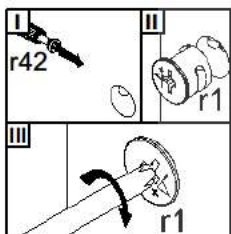
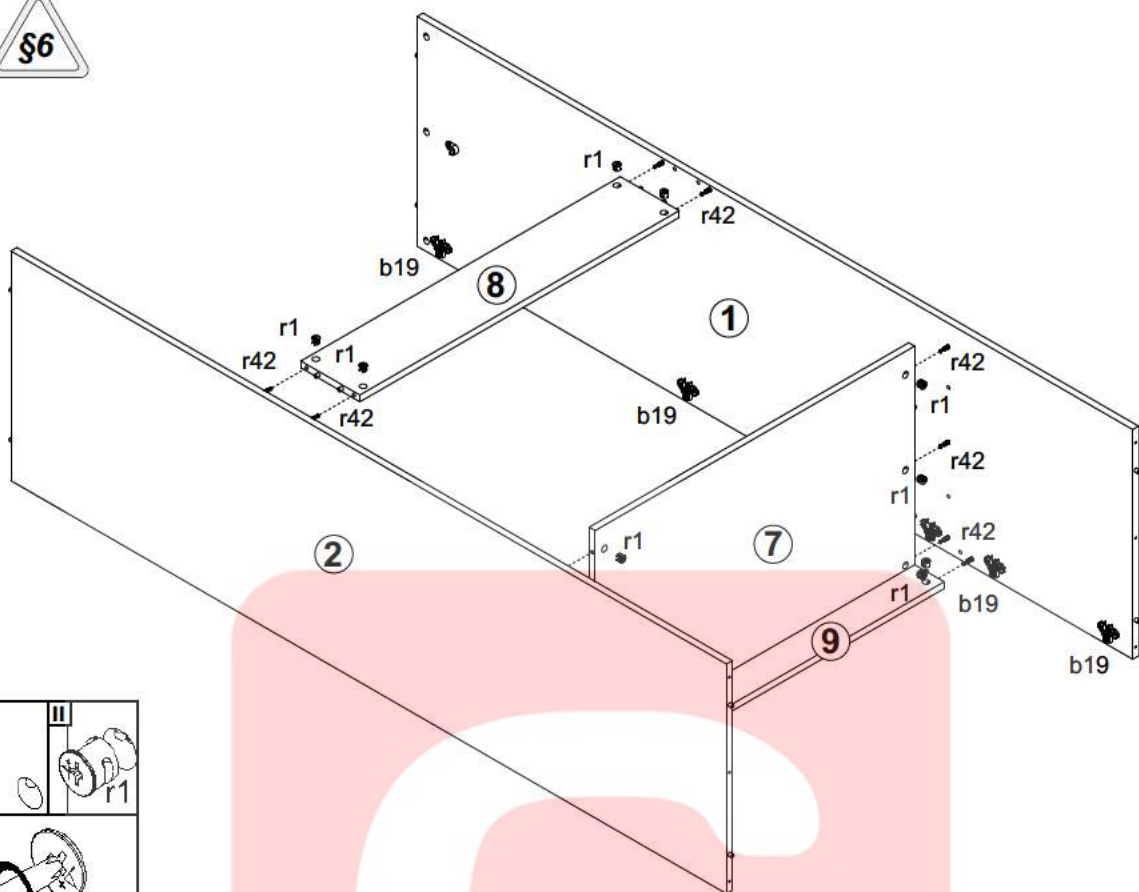

3

