

A	B	C		D
1	S162 0007	482	482	3/3
2	S162 0008	482	506	3/3
3	S162 0009	482	506	3/3
4	S162 1109	1091	371	1/3
5	S162 1110	1091	371	1/3
6	S162 1111	1016	371	1/3
7	S162 2204	1008	397	1/3
8	S162 3304	974	371	1/3
9	S162 3305	478	371	2/3
10	S162 3306	477	370	2/3
11	S162 4410	478	60	2/3
12	S162 4412	975	60	1/3
13	S162 9908	1041	249	1/3
14	Lh 1044	1011	14	1/3

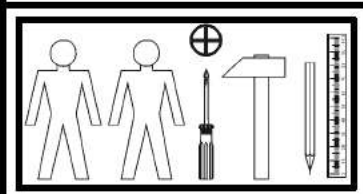

8x a68	8x b19	16x d1 ø 5x17 mm	16x e2 ø5,5x13 mm	32x f1 ø8x30 mm	4x k1	75x l1	16x p51 ø8,5x15 mm	20x r1 ø15x12mm #16
20x r42	1x n26\1	1x p38 ø3,5x16 mm	5x s2 ø16	4x f6 LB x50 mm				

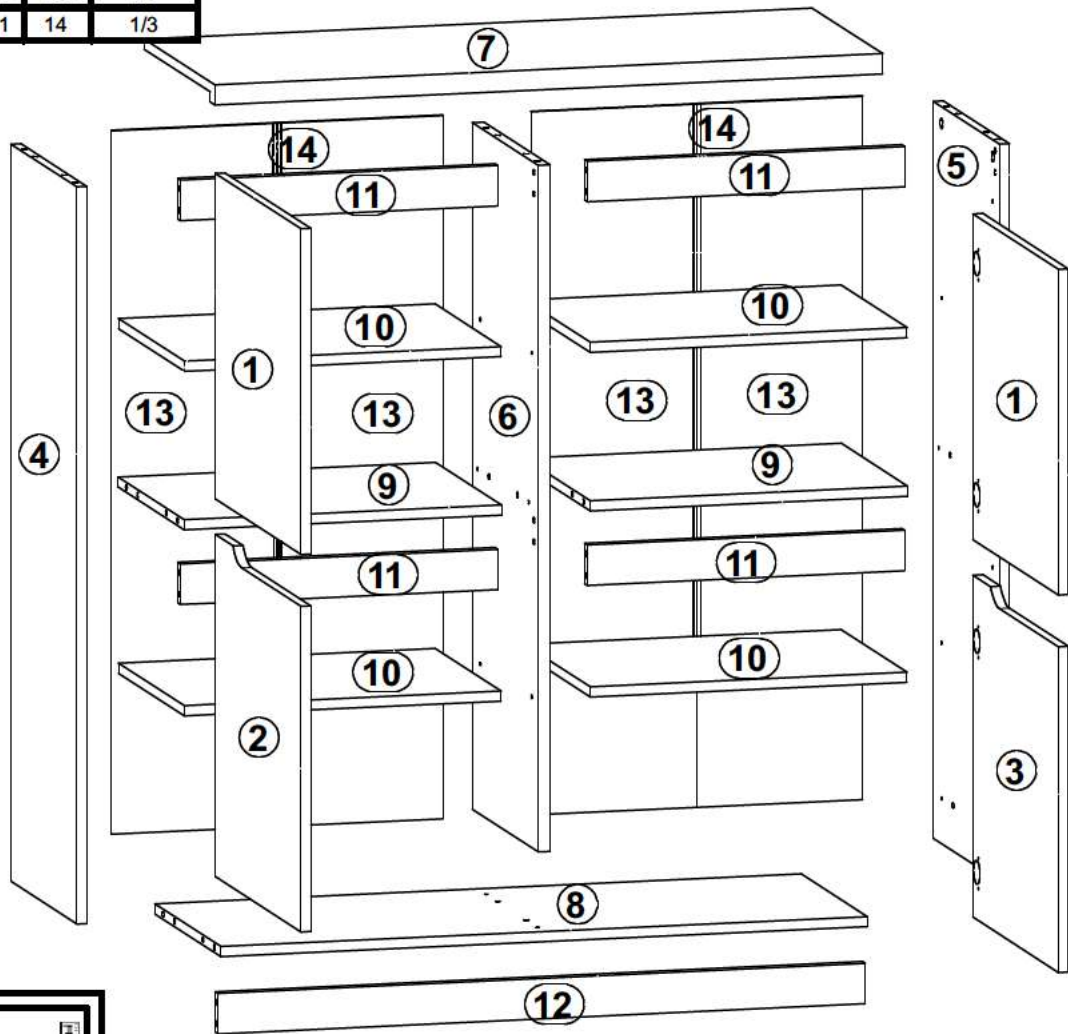
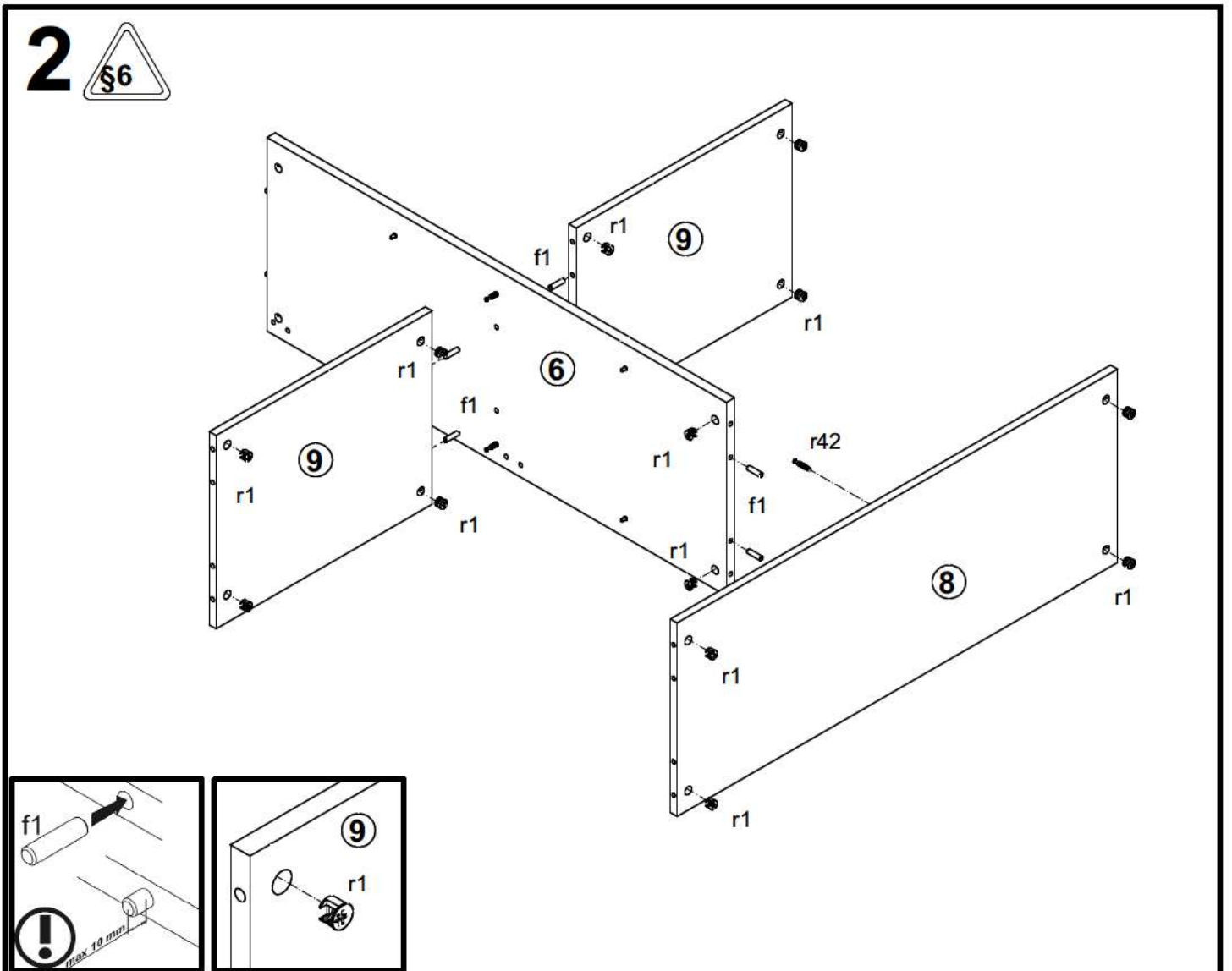
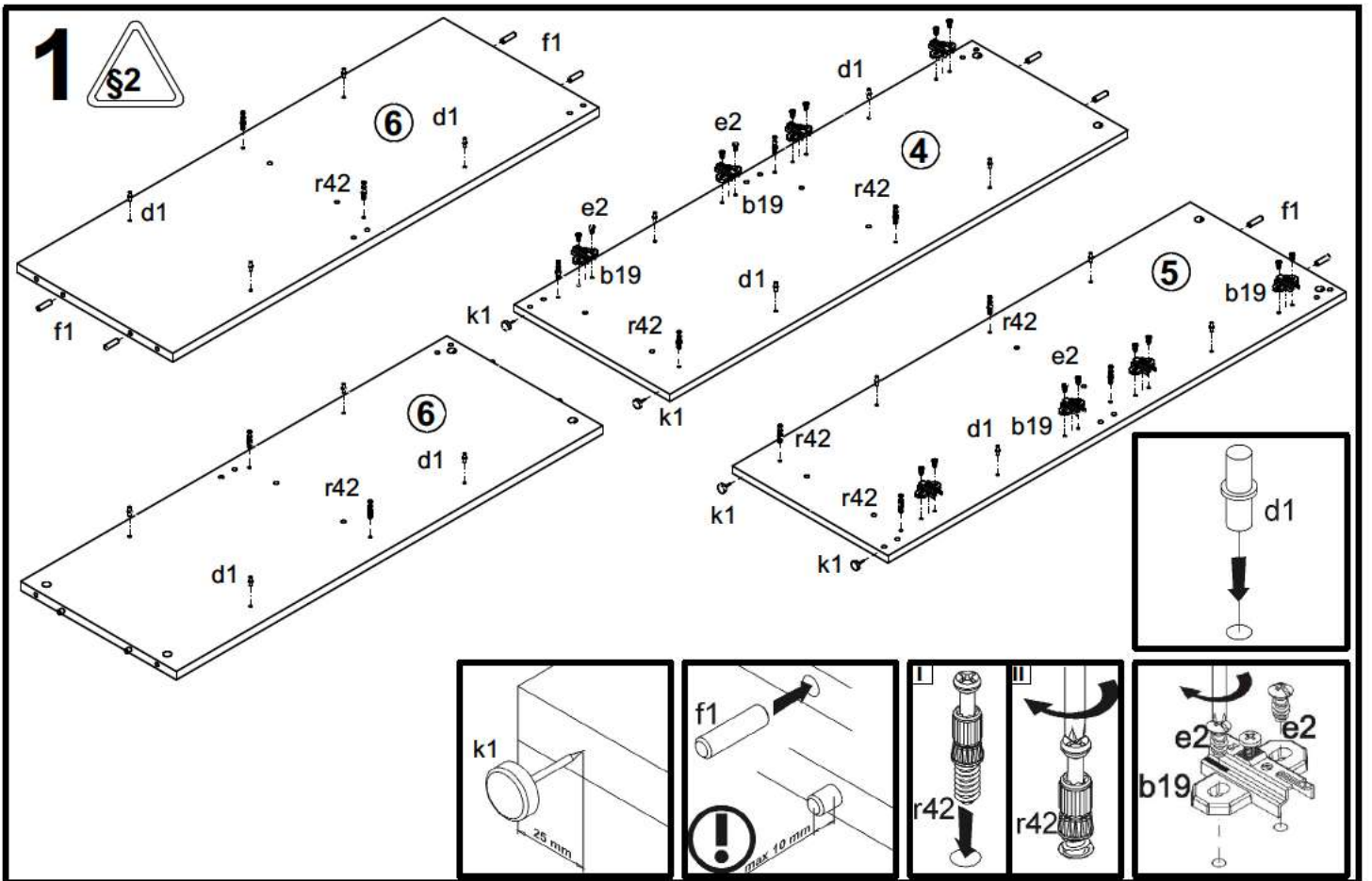

3

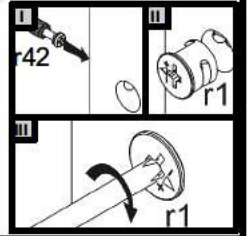
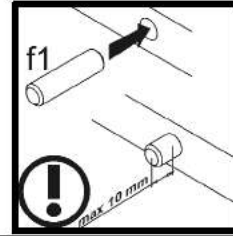
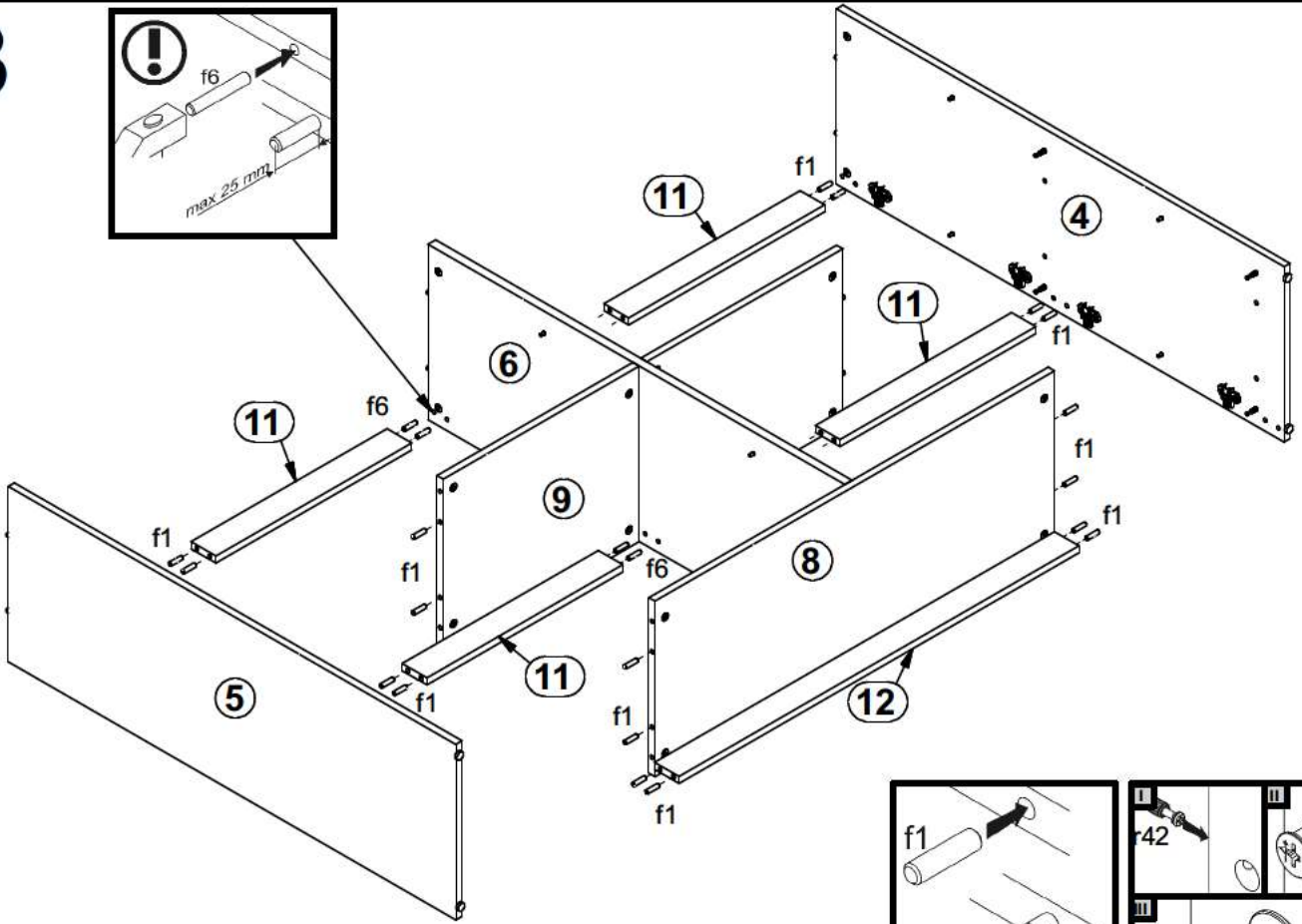
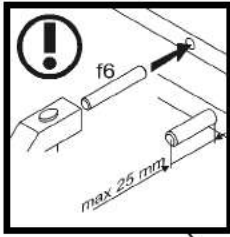

4

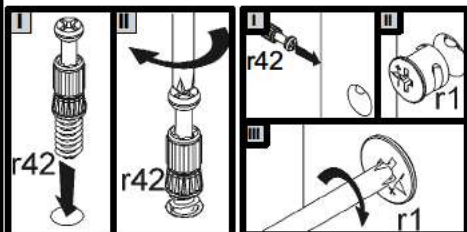
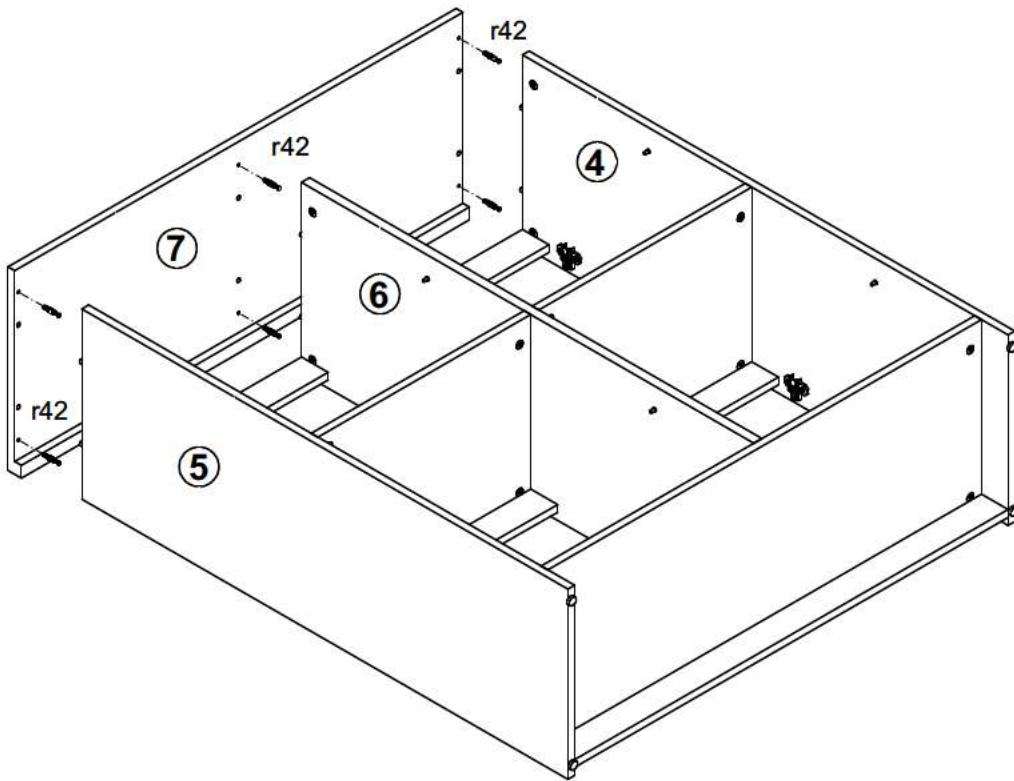

5

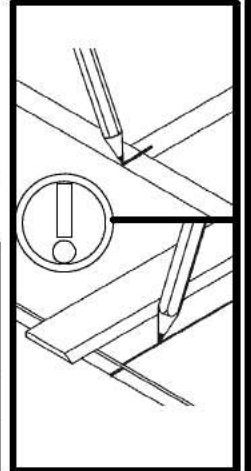
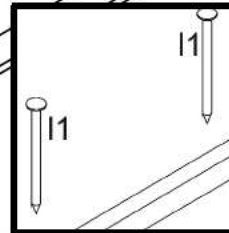
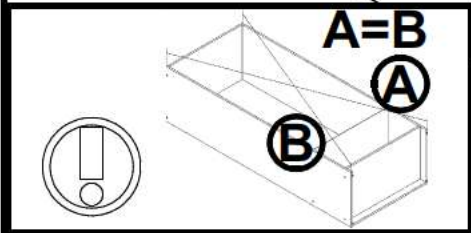
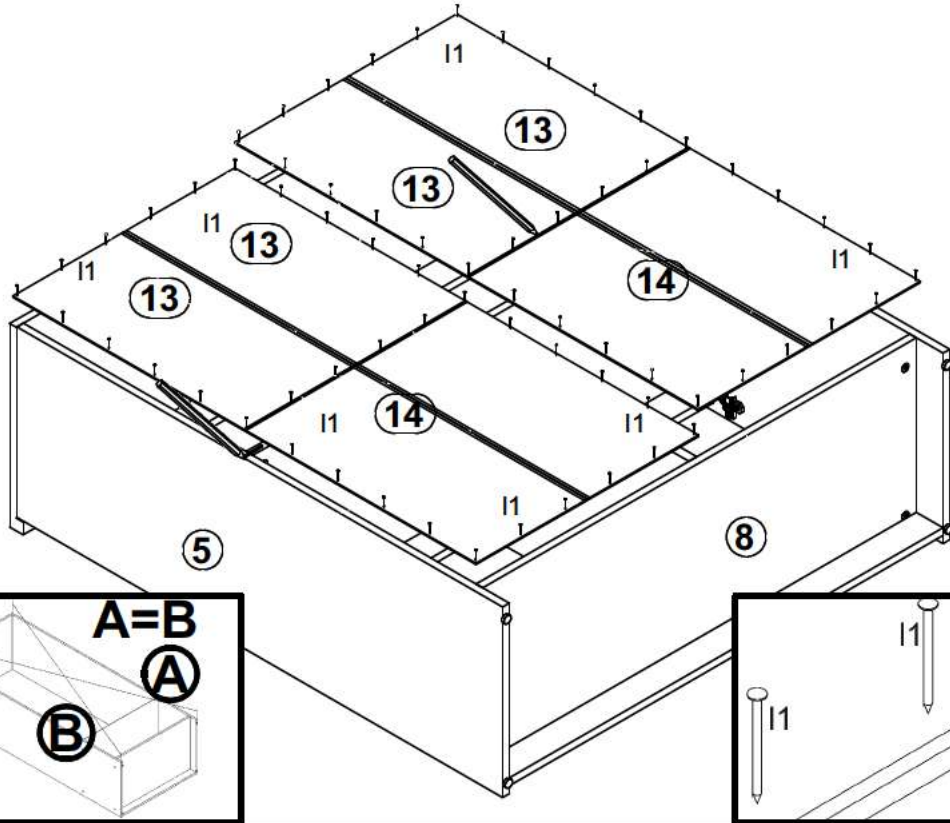

6

